

Coupling Decoupling Network Emission (CDNE)

1 Introduction

CDNEs are a type of Coupling Decoupling Networks used for an alternative technique of measuring radiated emission of lighting equipment in accordance with the CISPR 15 (EN55015) standard.

It avoids the need for emission measurements on Open Area Test Sites. This method was established in CISPR 15 edition 9 as an acceptable alternative to a traditional OATS test configuration that required antennas and calibrated test sites. It is specified for the frequency range from 30 MHz to 300 MHz. The CDNE method and the associated limits up to 300 MHz can be only applied for EUTs with clock frequencies below or equal to 30 MHz. In such a case, the product is deemed to comply with the requirements between 300 MHz and 1000 MHz.

When compared to CDNs, CDNEs are substantially more stringently specified, with reduced common mode (CM) impedance tolerance and additional parameters for CM phase tolerance and differential mode impedance equal to 100 Ω . A minimum 20 dB for longitudinal conversion loss shall prevent symmetrical voltage influencing measurement results.

CISPR 15 edition 9 also specifies that the mains supply cable of the EUT should be terminated with a CDNE positioned on the reference-ground plane for the OATS, SAC or FAR measurement method.

Unlike CDNs, CDNEs are not appropriate for immunity measurements

The Tekbox TBCDNE-M3 is designed for measuring EUTs with PE, Neutral, and Line connections. Tekbox offers the TBCDN-M2 model for measuring EUTs that do not have a PE (Earth) connection.



Coupling Decoupling Network Emission (CDNE)

2 Specifications

Compliance:	CISPR 15 (IEC / EN 55015) Edition 9, CISPR 16-1-2, CISPR 16-2-1
Maximum supply voltage:	300V AC, 600V DC
Maximum current:	16A
Frequency range:	30 MHz – 300 MHz
Common mode impedance:	150 Ω +10 / - 20 Ω (EUT port)
Phase response:	0° ± 25° (EUT port)
Differential mode impedance:	100 Ω ± 20 Ω (EUT port)
Voltage Division Factor:	20 dB ± 1.5 dB (EUT to RF output)
AE to EUT decoupling:	> 30 dB
AE to RF output decoupling:	> 30 dB
RF output connector:	N – female
EUT / AE connectors:	4 mm banana safety jacks, 4 mm slots in base plate for GND connection
Housing material:	powder coated aluminium, stainless steel base plate
Dimensions:	300 x 150 x 150 mm
Weight:	ca. 2.5 kg
Included:	NIST traceable calibration data
Optional accessories:	Adapter panel with shorting bar and N-connector 50 Ω to 150 Ω adapter panel for VDF measurement / calibration OSL adapters for common mode impedance measurement / calibration Balun and OSL adapters for differential mode impedance measurement / calibration

3 Informative schematic

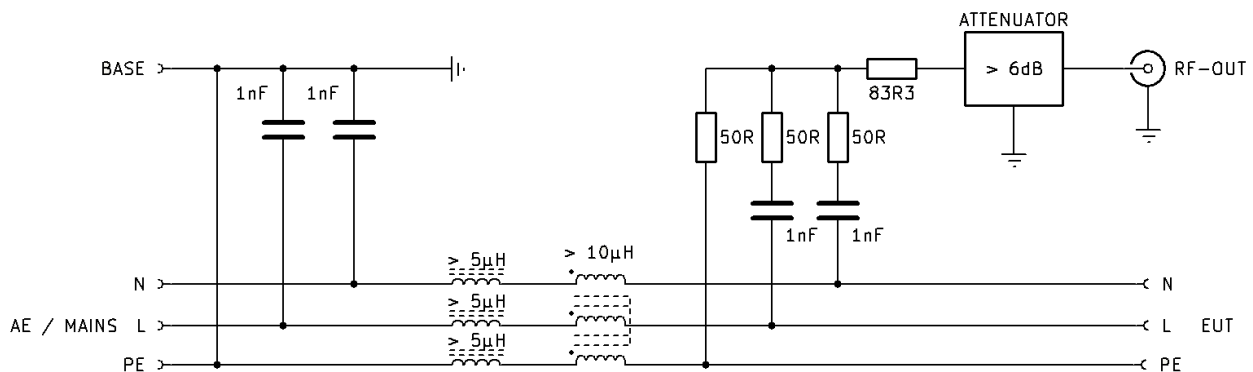

CDNE-M3, informative schematic

Coupling Decoupling Network Emission (CDNE)

4 Typ. Voltage Division Factor

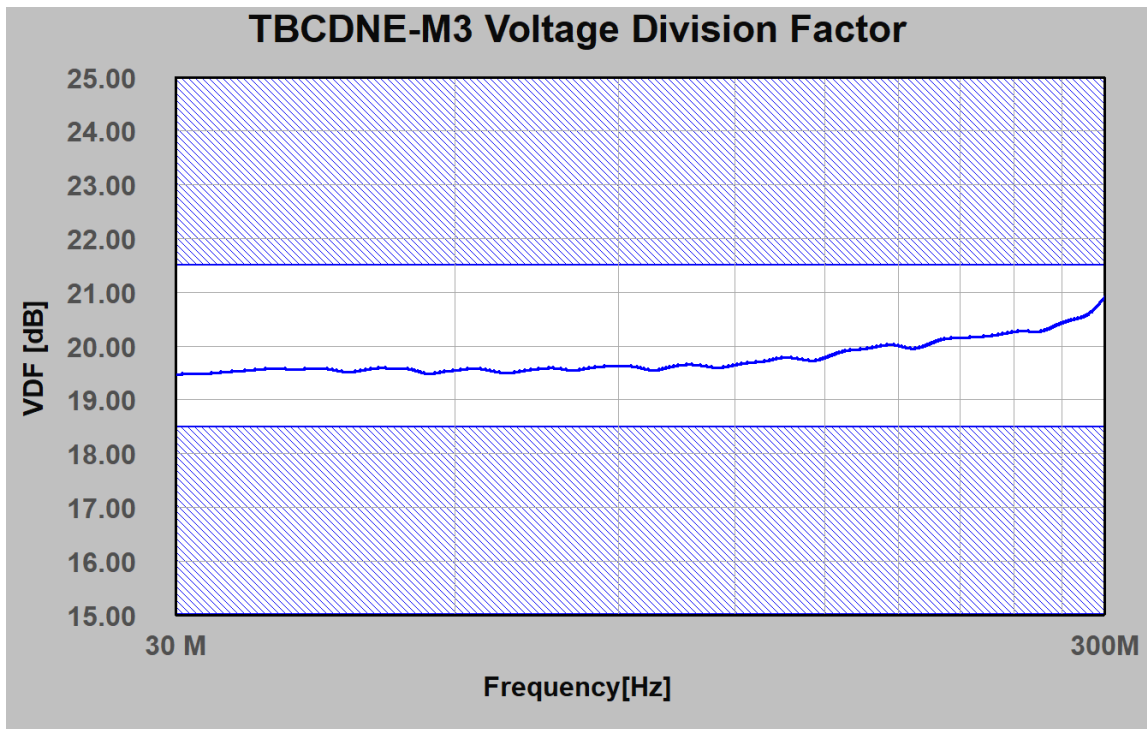

5 Typ. EUT common mode impedance

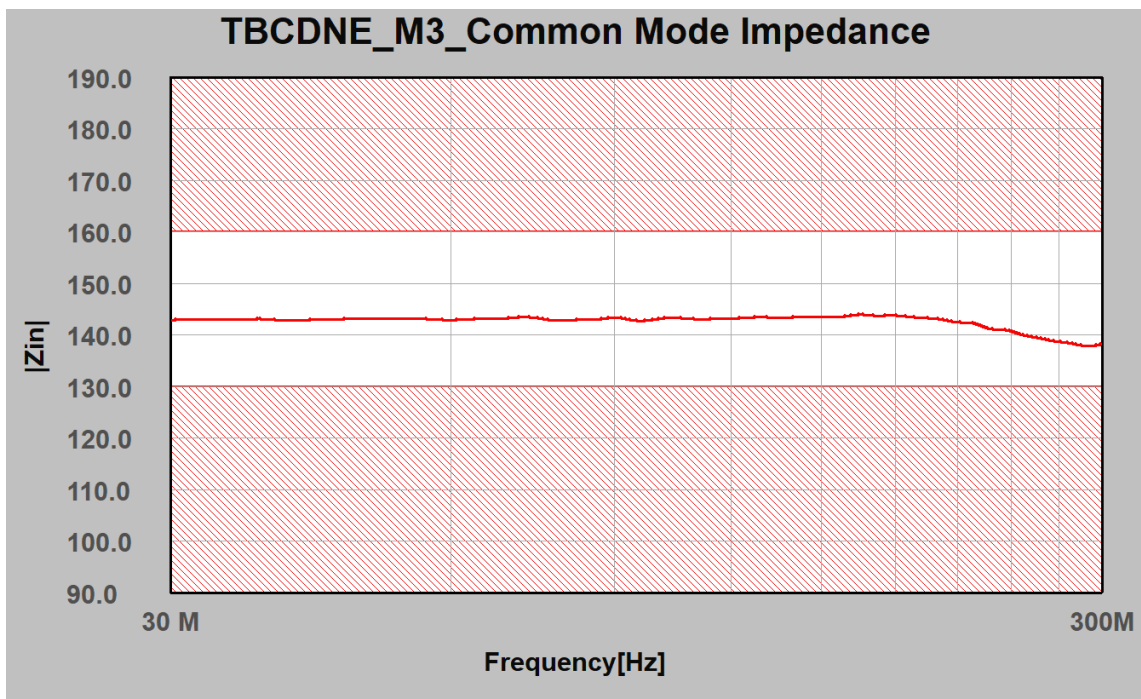

Coupling Decoupling Network Emission (CDNE)

6 Typ. EUT differential mode impedance

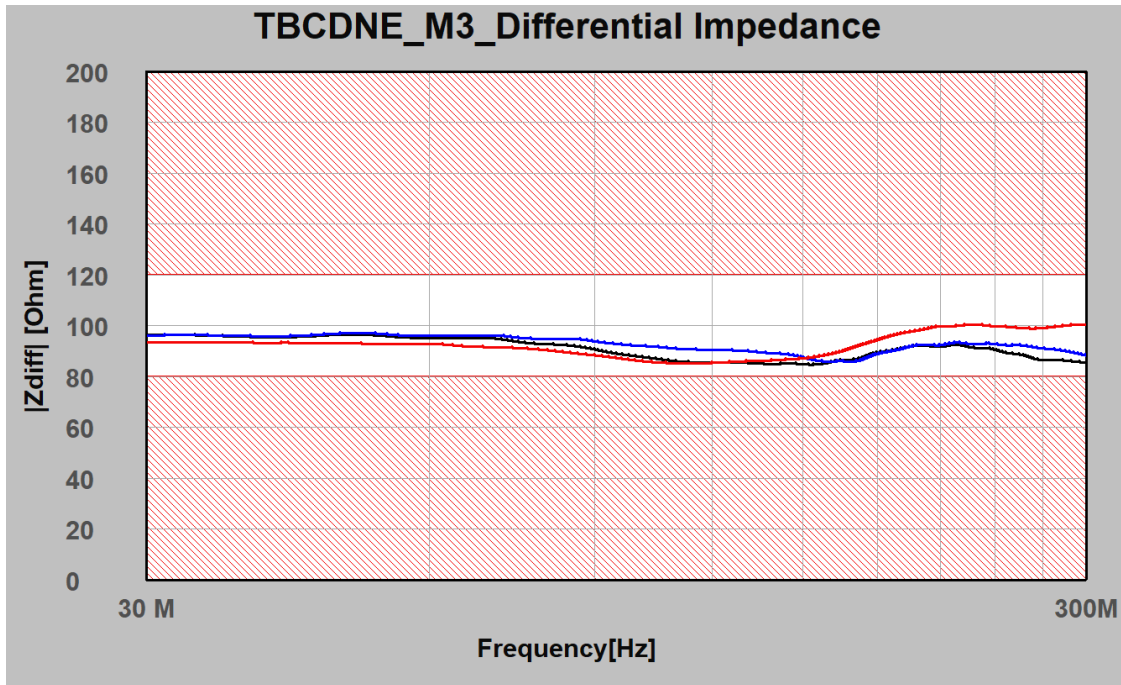

7 Typ. EUT common mode phase response

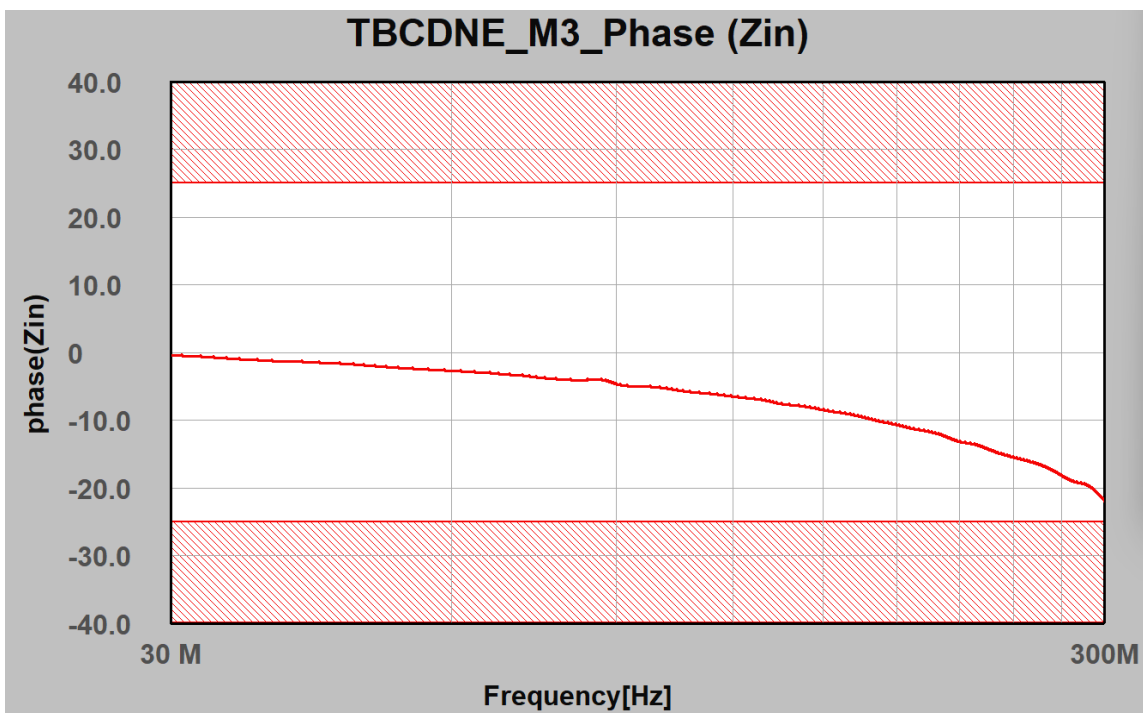

Coupling Decoupling Network Emission (CDNE)

8 Typ. Decoupling, AE to EUT

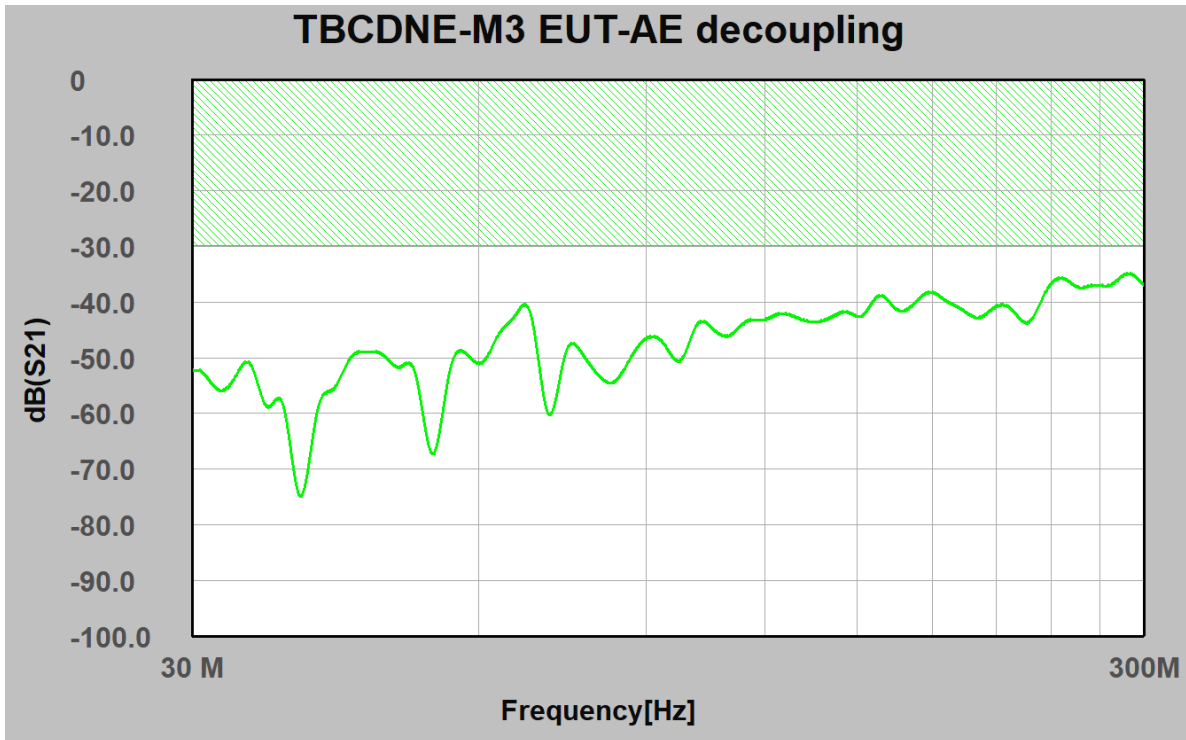

9 Typ. Decoupling, AE to RF

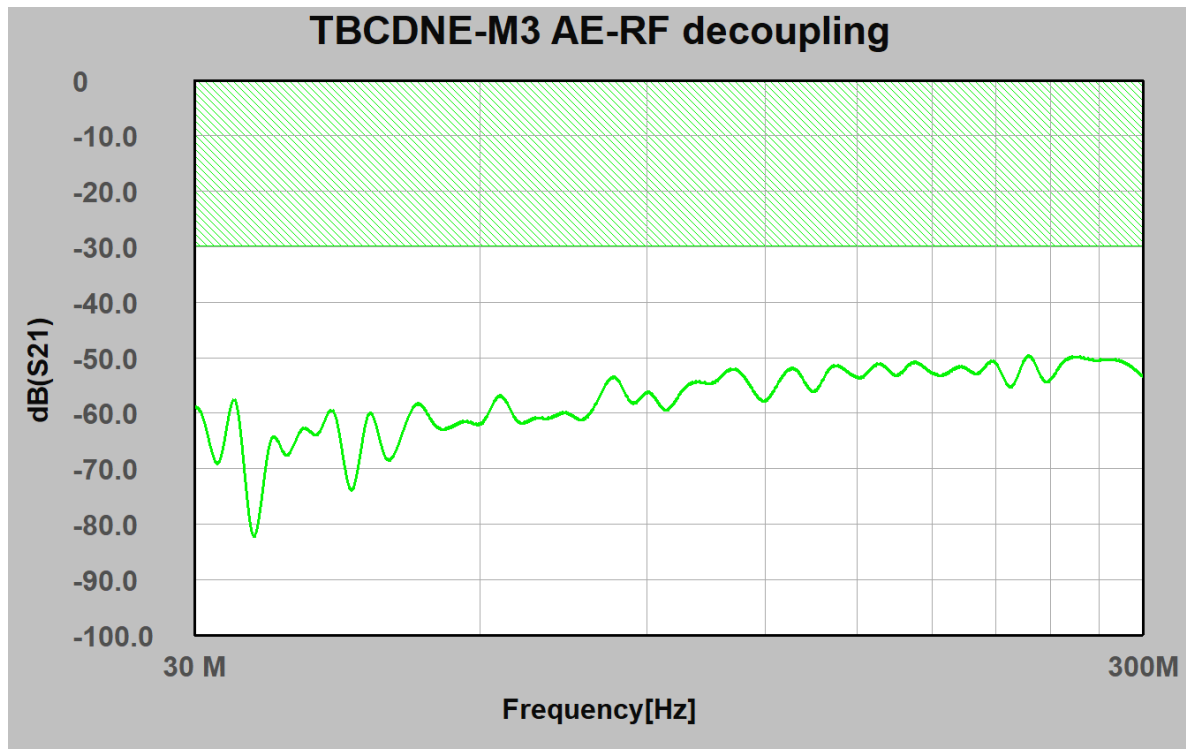

Coupling Decoupling Network Emission (CDNE)

10 Measurement Setups

When the CDNE method is used and all clock frequencies of the EUT are below or equal to 30 MHz, then the product is deemed to comply with the requirements between 300 MHz and 1 000 MHz if the emissions comply with the limits in the 30 MHz to 300 MHz frequency range as specified in CISPR 15 (IEC / EN 55015). If the CDNE test fails, then any of the other methods and corresponding limits specified in CISPR 15 can still be applied

For the CDNE method, the largest dimensions of the EUT are 3 m x 1 m x 1 m (l x w x h). The CDNE restrictions apply to the EUT only, and not the wiring or the total dimension of the system under test.

When using the CDNE method to show compliance to 1 GHz, the test report shall include a statement (from the manufacturer) that the clock frequency is below 30 MHz.

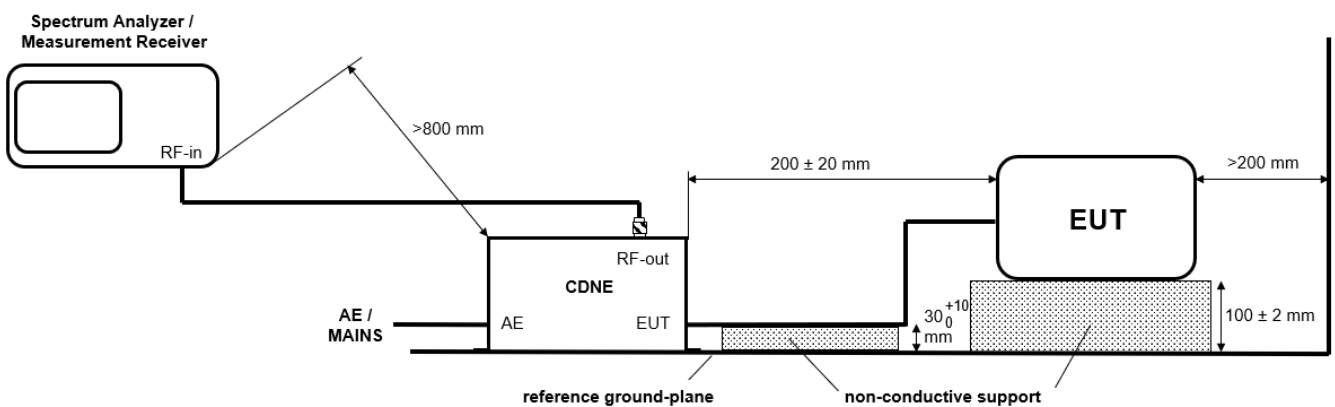

Setup for emission measurement of an EUT with one cable; frequency range 30 MHz to 300 MHz

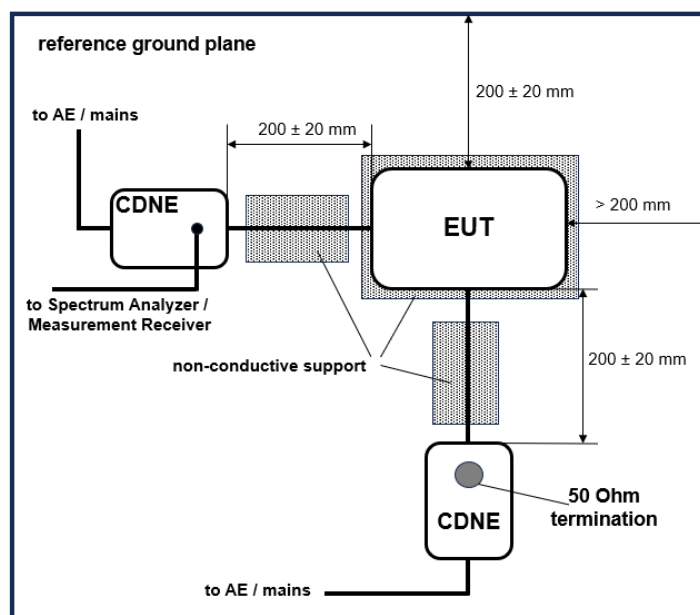

Setup for emission measurement of an EUT with two cables connected to adjacent surfaces of the EUT; frequency range 30 MHz to 300 MHz

Coupling Decoupling Network Emission (CDNE)

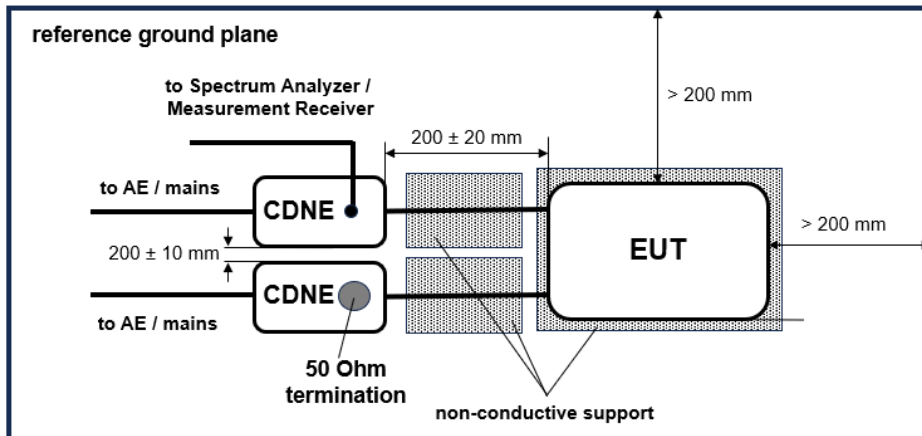

Setup for emission measurement of an EUT with two cables connected on the same surface of the EUT; frequency range 30 MHz to 300 MHz

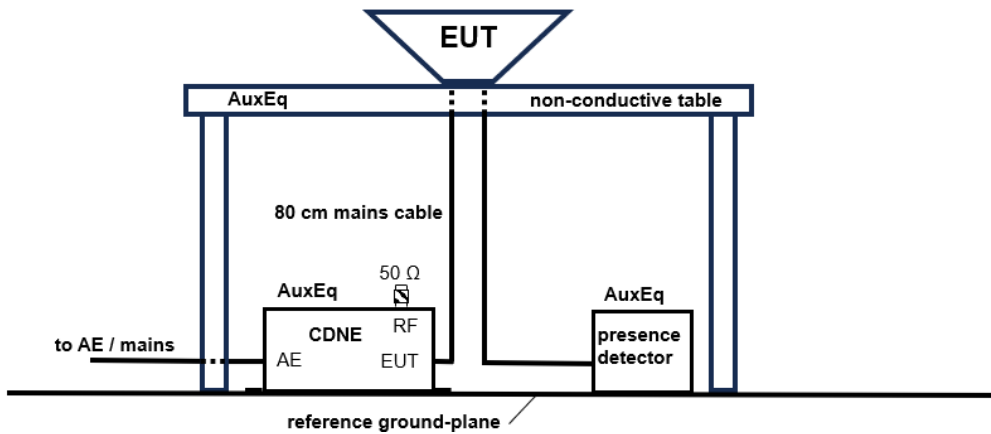

Example of arrangement of a luminaire during the radiated (OATS, SAC or FAR) disturbance measurement

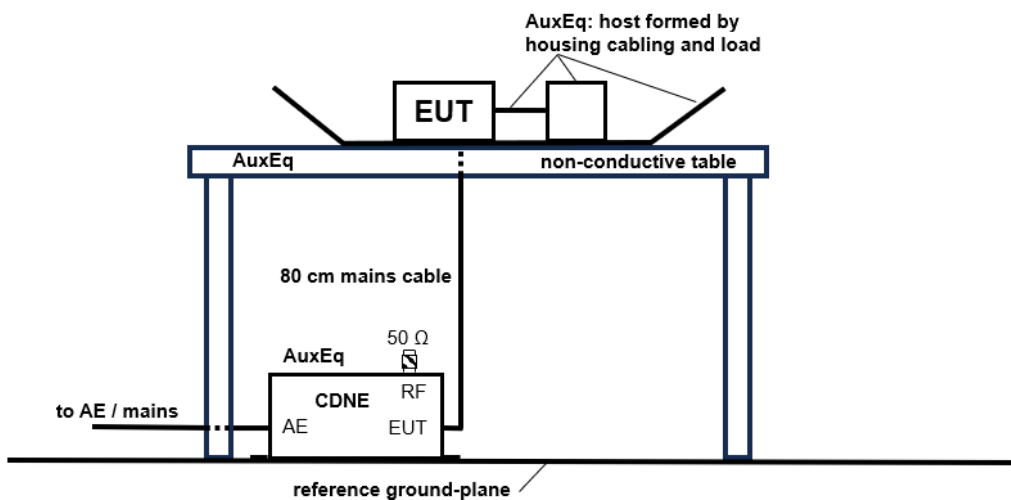

Example of arrangement of an internal module during the radiated (OATS, SAC or FAR) disturbance measurement

Coupling Decoupling Network Emission (CDNE)

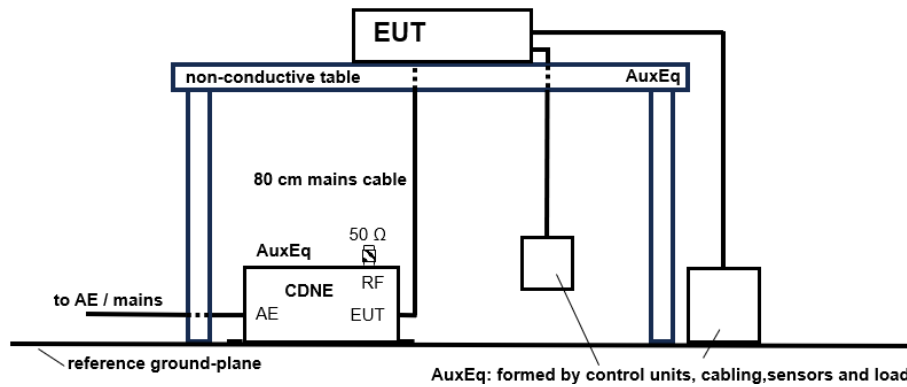

Example of arrangement of an external module during the radiated (OATS, SAC or FAR) disturbance measurement

11 References

CISPR 16-1-2 Edition 2.0 2014-03
 CISPR 16-2-1 CISPR 16-2-1 Edition 3.0 2014-02
 CISPR 15 Edition 9 (IEC / EN 55015:2019+A11:2020)

12 Ordering Information

Part Number	Description
TBCDNE-M3	M3 CDNE
TBCDN-M3-AP	Adapter panel with shorting bar for M3 CDNE
TBCDNE-M3-CAL1	50 Ω to 150 Ω adapter panel for VDF measurement / calibration
TBCDNE-M3-CAL2	OSL adapters for common mode impedance measurement / calibration
TBCDNE-MX-CAL3	Balun and OSL adapters for differential mode impedance measurement / calibration

13 History

Version	Date	Author	Changes
V1.0	3.10.2023	Mayerhofer	Creation of the document
V1.1	2.11.2023	Mayerhofer	Update of chapter 1

www.tekbox.com

TekBox Digital Solutions Vietnam Pte. Ltd.

Factory 4, F4, Lot I-3B-1, Saigon Hi-Tech Park, Tan Phu Ward, District 9, Ho Chi Minh City, Vietnam