

LB-1801100-1.0F Broadband Horn Antenna 18-110GHz 14dB Gain 1.0mm Female

Broadband Horn Antenna Operating From 18GHz to 110GHz With a Nominal 14dB Gain With 1.0mm Female Connector, Carrying Box included



Product Information

SKU	LB-1801100-1.0F	Patents	US 11442093 (USA) US D978843 (USA)
-----	-----------------	---------	---------------------------------------

Description

Broadband horn antenna LB-1801100-1.0F, operating from 18 to 110GHz with a nominal 14dB gain and low VSWR 1.5:1 with 1.0mm Female output connector. The model LB-1801100-1.0F has uniform gain through its frequency span, providing efficient performance characteristics and directionality. It can handle 4W continuously and 8W peak power. Constructed of lightweight corrosion-resistant aluminum, the antenna will provide years of trouble-free indoor and outdoor service. This broadband horn antenna is linearly polarized and ideally suited for EMI testing, direction finding, surveillance, antenna gain and pattern measurements and other applications.

Technical Specification

Electrical Specification		Interface	
Frequency, Min (GHz)	18	Output Type	Coaxial
Frequency, Max (GHz)	110	Connector	1.0mm
Gain, Typ (dBi)	14	Connector Gender	Female
Polarization	Linear	Mechanical Specification	
3dB Beamwidth, E-Plane, Min (Deg.)	11	Body Material	Al
3dB Beamwidth, E-Plane, Max (Deg.)	66	Finish	Gold Plated and Chemical Conversion Coating
3dB Beamwidth, H-Plane, Min (Deg.)	9	Size, W (mm)	41.3
3dB Beamwidth, H-Plane, Max (Deg.)	59	Size, H (mm)	41.3
Cross Pol. Isolation, Typ (dB)	35	Size, L (mm)	65
VSWR, Typ	1.5:1	Weight, (kg)	0.1
Impedance, (Ohm)	50		
Power Handling, CW, (W)	4		
Power Handling, Peak, (W)	8		

Additional Information

Application	General Purpose Indoor & Outdoor, Fixed	Solution for	Gain Reference Antenna Measurement Reflector Feed Far-field Measurement System Intergration
-------------	---	--------------	---

Outline Drawing

1.0mm-Female Output (P/N: LB-1801100-1.0F)

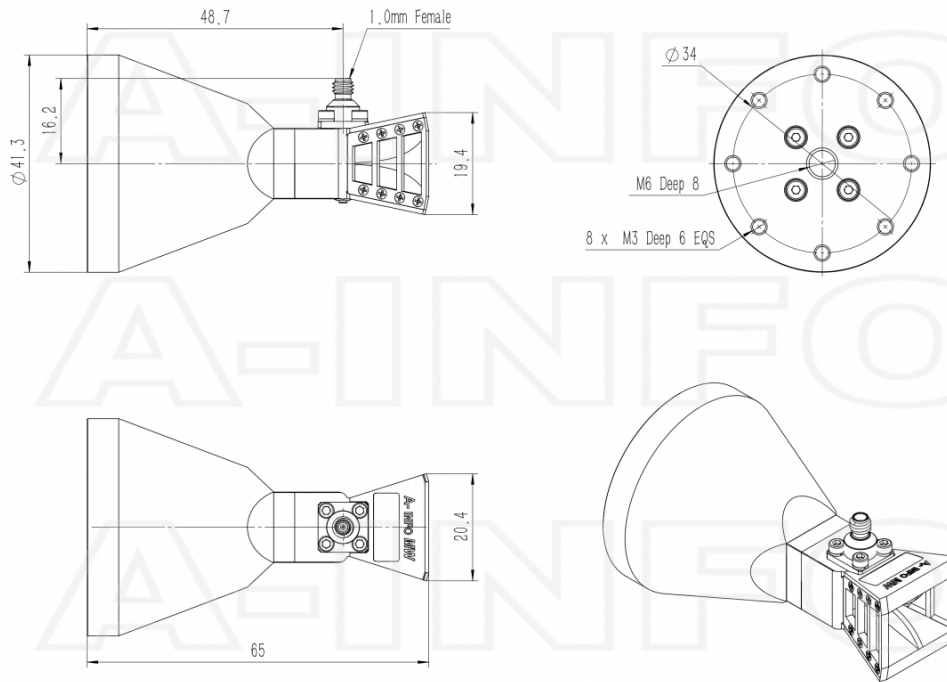

1.0mm-Female Output with L Type Mounting Bracket(Option, P/N:LB-20180-L)

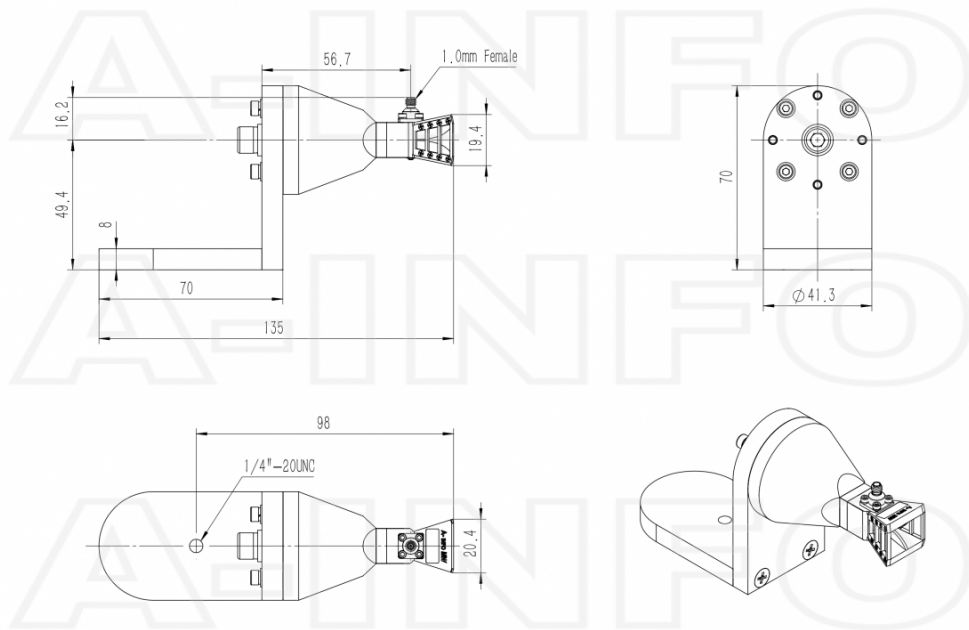

Typical Test Results

Gain

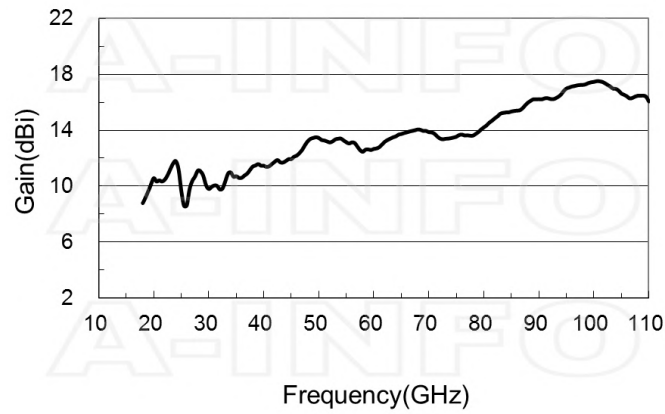

Antenna Factor

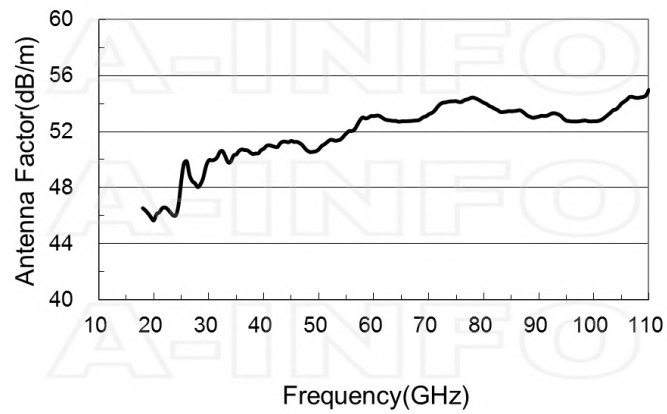

Antenna Factor (Table)

Frequency(GHz)	Gain(dBi)	Antenna Factor(dB/m)
18.0	8.78	46.53
19.0	9.64	46.15
20.0	10.57	45.66
25.0	9.67	48.50
30.0	9.80	49.95
35.0	10.71	50.38
40.0	11.47	50.78
45.0	11.93	51.34
50.0	13.45	50.74
55.0	13.14	51.87
60.0	12.67	53.11
65.0	13.73	52.74
70.0	13.87	53.25
75.0	13.54	54.17
80.0	14.21	54.06
85.0	15.34	53.45
90.0	16.23	53.07
95.0	16.99	52.78
100.0	17.47	52.74
105.0	16.63	54.00
110.0	16.06	54.97

Cross Polarization Isolation

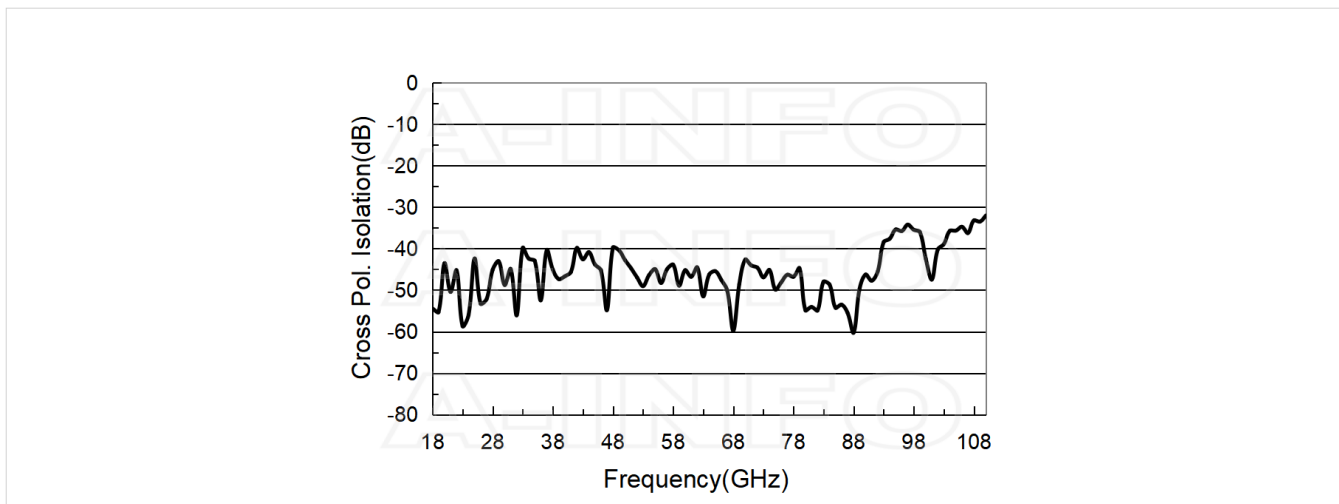

VSWR

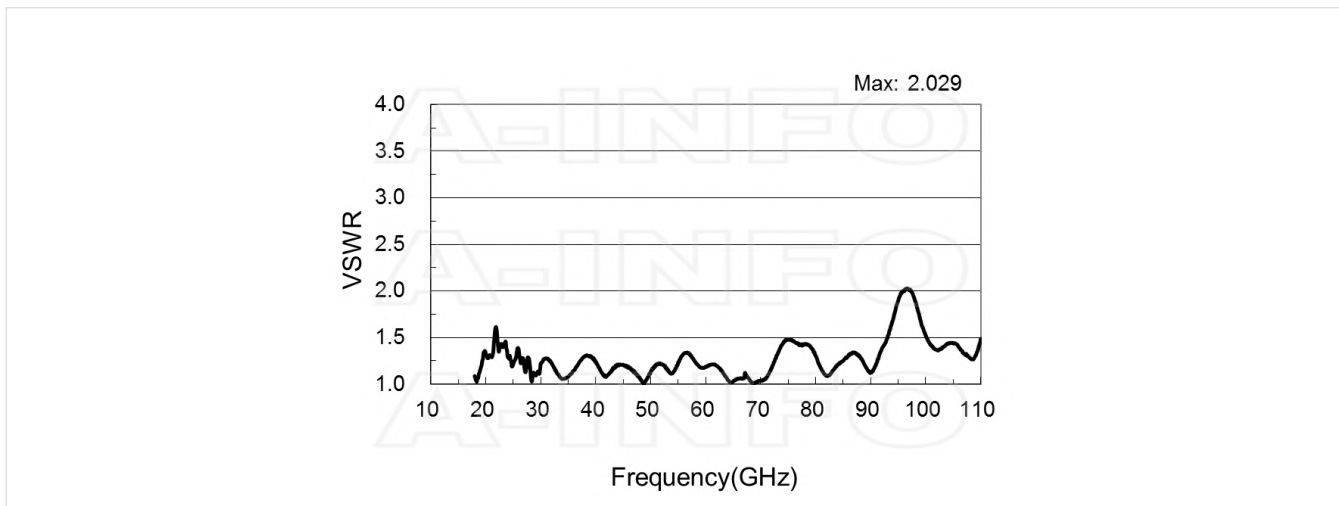

Beamwidth

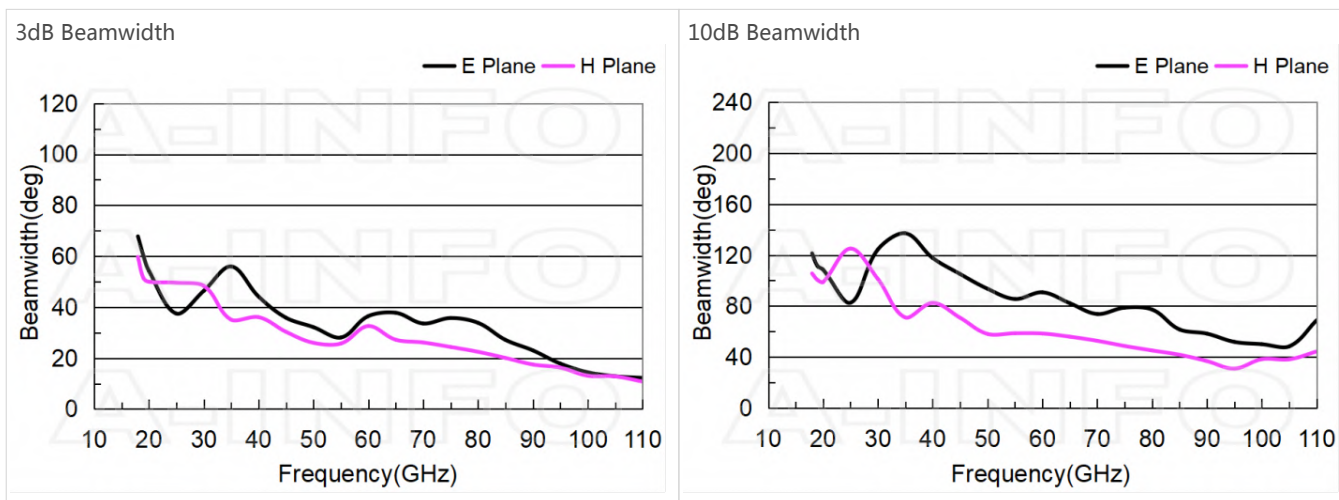

Pattern

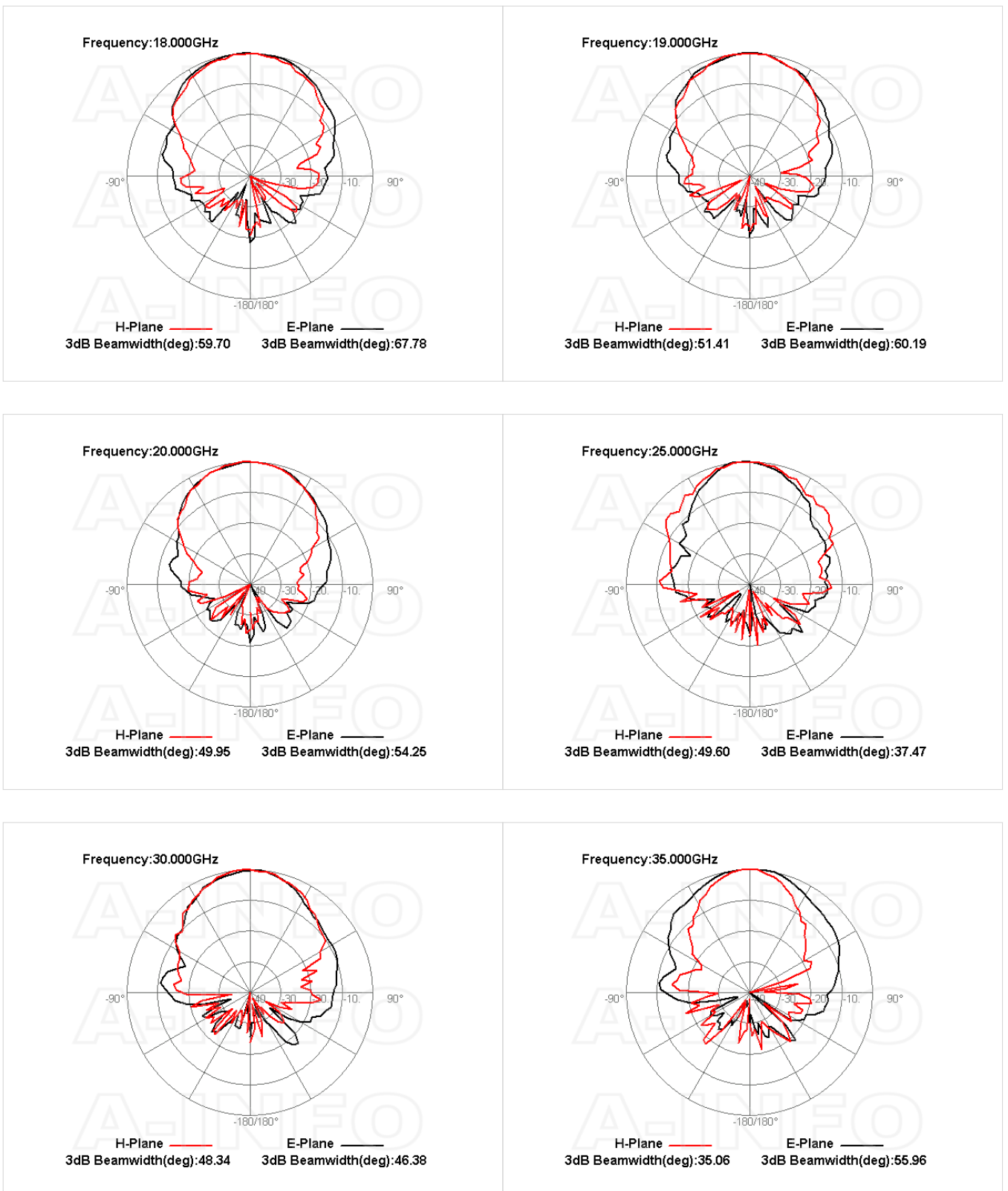

Frequency:40.000GHz

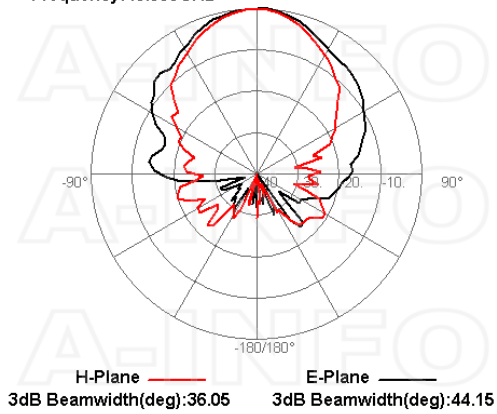

Frequency:45.000GHz

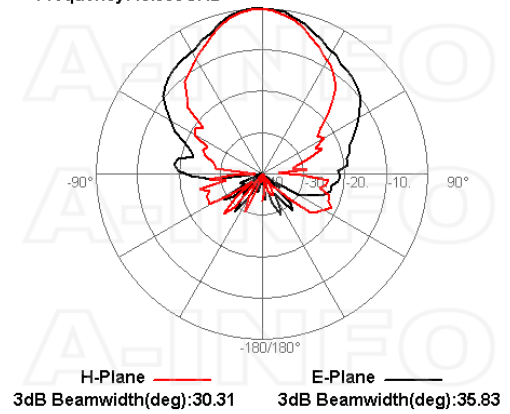

Frequency:50.000GHz

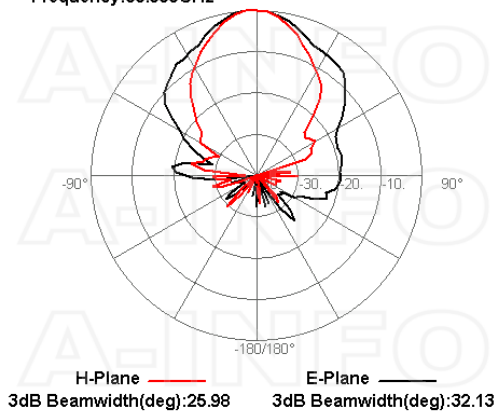

Frequency:55.000GHz

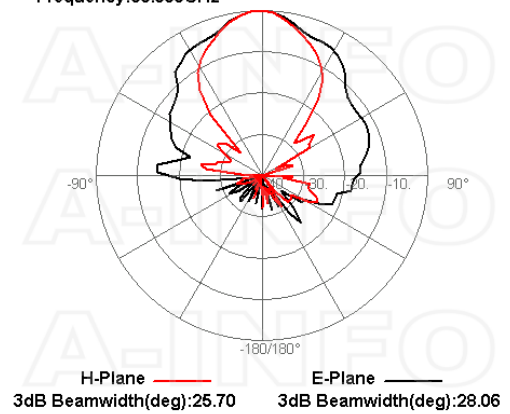

Frequency:60.000GHz

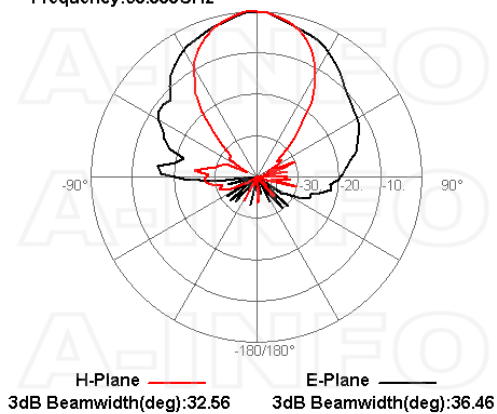

Frequency:65.000GHz

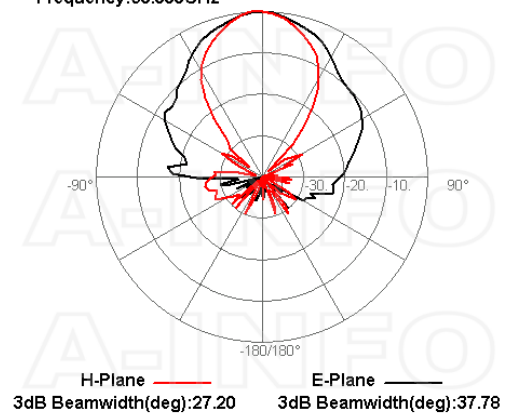

Frequency:70.000GHz

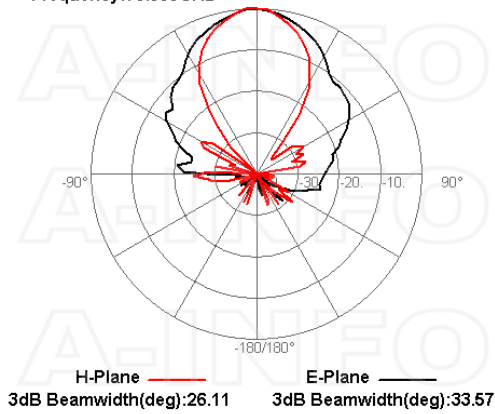

Frequency:75.000GHz

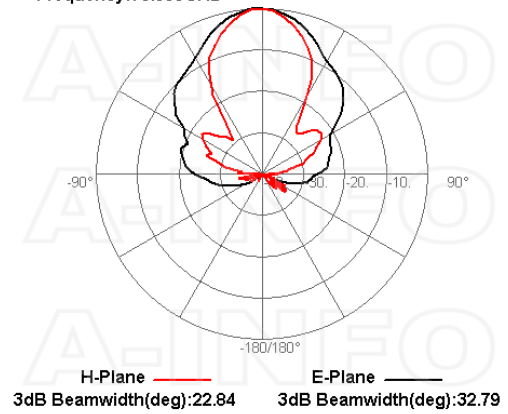

Frequency:80.000GHz

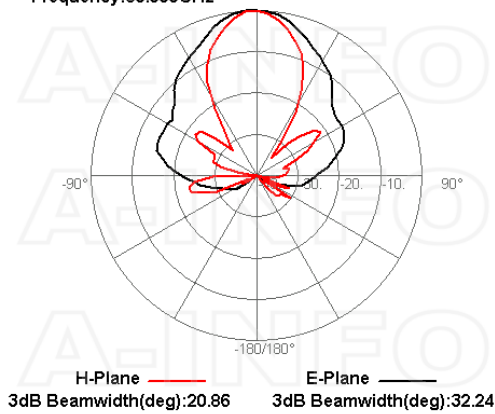

Frequency:85.000GHz

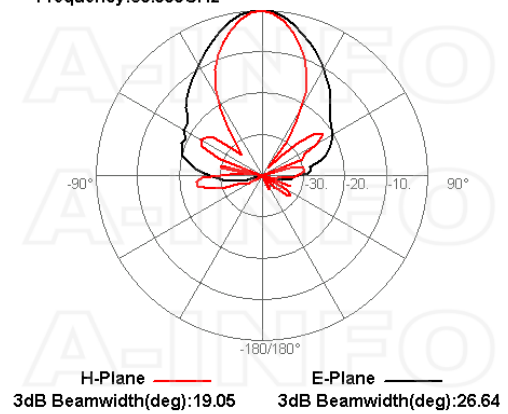

Frequency:90.000GHz

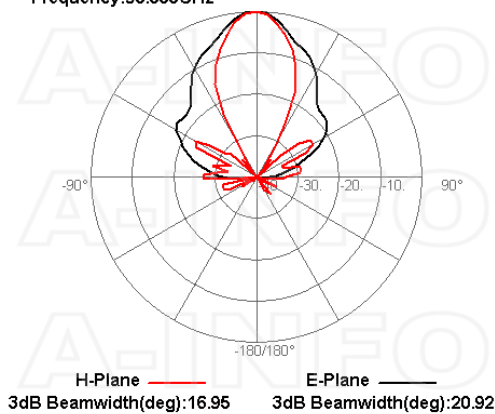

Frequency:95.000GHz

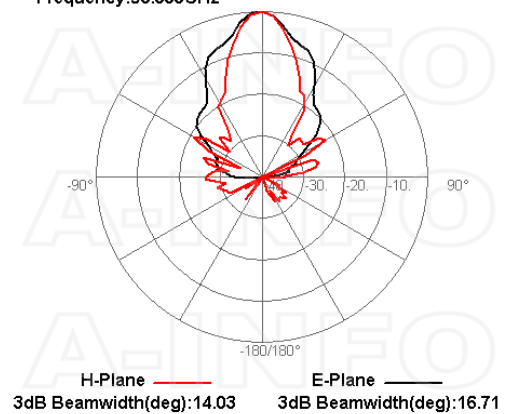

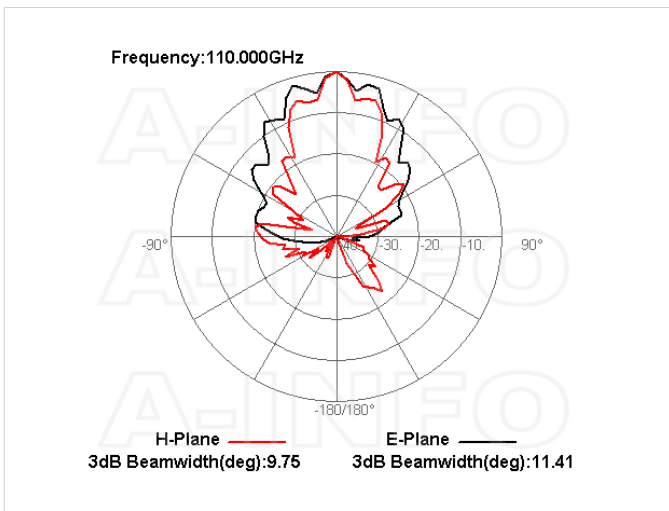
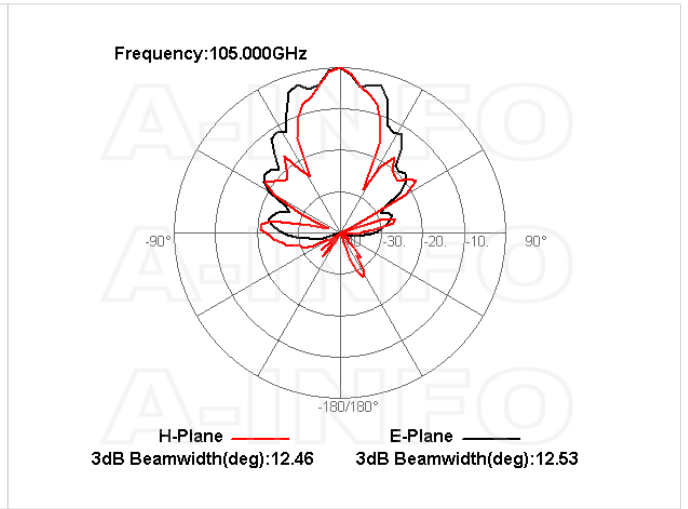
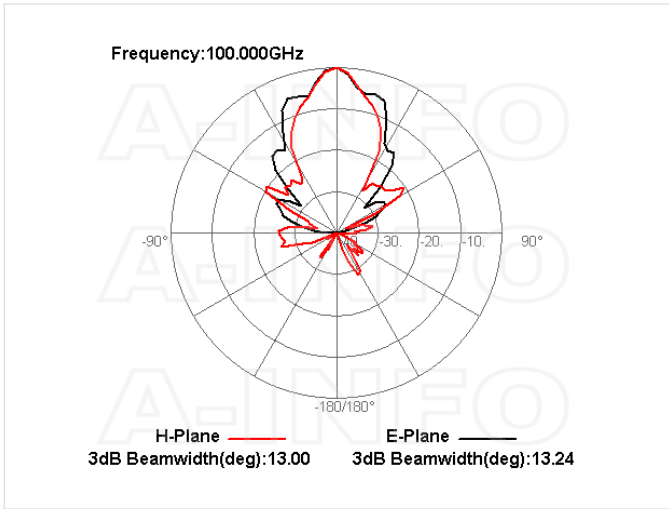

Related Products



LB-20180-L L Type Mounting Bracket



Tripod_15Kg Al Alloy Tripod



3033HL Wooden Tripod



3033QM Wooden Tripod Metalfree



1.0M-1.0M-C010-150 Flexible Cable Assembly 150mm DC-110GHz 1.0mm Male to 1.0mm Male



1.0M-1.0M-C010-200 Flexible Cable Assembly 200mm DC-110GHz 1.0mm Male to 1.0mm Male



1.0M-1.0M-C010-300 Flexible Cable Assembly 300mm DC-110GHz 1.0mm Male to 1.0mm Male



1.0M-1.0M-C010-500 Flexible Cable Assembly 500mm DC-110GHz 1.0mm Male to 1.0mm Male



1.0M-1.0M-C010-1000 Flexible Cable Assembly 1000mm DC-110GHz 1.0mm Male to 1.0mm Male



1.0M-1.0M-C010-1500 Flexible Cable Assembly 1500mm DC-110GHz 1.0mm Male to 1.0mm Male



1.0M-1.0M-C010-2000 Flexible Cable Assembly 2000mm DC-110GHz 1.0mm Male to 1.0mm Male



1.0M-1.0M-C010-3000 Flexible Cable Assembly 3000mm DC-110GHz 1.0mm Male to 1.0mm Male



1.0M-1.0M-C010-5000 Flexible Cable Assembly 5000mm DC-110GHz 1.0mm Male to 1.0mm Male



1.0M-1.0M-C010-10000 Flexible Cable Assembly 10000mm DC-110GHz 1.0mm Male to 1.0mm Male



1.0M-1.0M-C010M-500 Flexible Cable Assembly 500mm DC-110GHz 1.0mm Male to 1.0mm Male



1.0M-1.0M-C010M-1000 Flexible Cable Assembly 1000mm DC-110GHz 1.0mm Male to 1.0mm Male



1.0M-1.0M-C010M-1500 Flexible Cable Assembly 1500mm DC-110GHz 1.0mm Male to 1.0mm Male



1.0M-1.0M-C010M-2000 Flexible Cable Assembly 2000mm DC-110GHz 1.0mm Male to 1.0mm Male



1.0M-1.0M-C010M-3000 Flexible Cable Assembly 3000mm DC-110GHz 1.0mm Male to 1.0mm Male



1.0M-1.0M-C010M-5000 Flexible Cable Assembly 5000mm DC-110GHz 1.0mm Male to 1.0mm Male



1.0M-1.0M-C010M-10000 Flexible Cable Assembly 10000mm DC-110GHz 1.0mm Male to 1.0mm Male



1.0M-1.0F-C010M-1000 Flexible Cable Assembly 1000mm DC-110GHz 1.0mm Male to 1.0mm Female



1.0M-1.0F-C010M-2000 Flexible Cable Assembly 2000mm DC-110GHz 1.0mm Male to 1.0mm Female



1.0M-1.0F-C010M-3000 Flexible Cable Assembly 3000mm DC-110GHz 1.0mm Male to 1.0mm Female



1.0M-1.0F-C010M-5000 Flexible Cable Assembly 5000mm DC-110GHz 1.0mm Male to 1.0mm Female



1.0M-1.0F-C010M-10000 Flexible Cable Assembly 10000mm DC-110GHz 1.0mm Male to 1.0mm Female

Similar Products



LB-180400-KF Broadband Horn Antenna 18-40GHz 15dB Gain 2.92mm Female



LB-180400-KM Broadband Horn Antenna 18-40GHz 15dB Gain 2.92mm Male

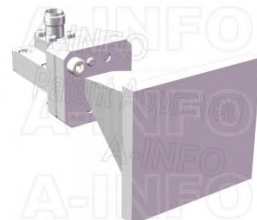

LB-180400-KFSP0 Broadband Horn Antenna 18-40GHz 15dB Gain 2.92mm Female



LB-180400-2.4F Broadband Horn Antenna 18-40GHz 15dB Gain 2.4mm Female

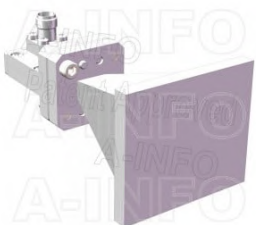

LB-180400-2.4FSP0 Broadband Horn Antenna 18-40GHz 15dB Gain 2.4mm Female



LB-180400H-KF Broadband Horn Antenna 18-40GHz 20dB Gain 2.92mm Female



LB-180400H-KM Broadband Horn Antenna 18-40GHz 20dB Gain 2.92mm Male



LB-180400H-KFSP0 Broadband Horn Antenna 18-40GHz 20dB Gain 2.92mm Female



LB-180400H-2.4F Broadband Horn Antenna 18-40GHz 20dB Gain 2.4mm Female



LB-180400H-2.4FSPO Broadband Horn Antenna 18-40GHz 20dB Gain 2.4mm Female



LB-180500-2.4F Broadband Horn Antenna 18-50GHz 15dB Gain 2.4mm Female

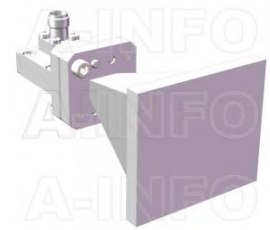

LB-180500-2.4FSPO Broadband Horn Antenna 18-50GHz 15dB Gain 2.4mm Female



LB-180500H-2.4F Broadband Horn Antenna 18-50GHz 20dB Gain 2.4mm Female



LB-180500H-2.4FSPO Broadband Horn Antenna 18-50GHz 20dB Gain 2.4mm Female



LB-180550-1.85F Broadband Horn Antenna 18-55GHz 15dB Gain 1.85mm Female

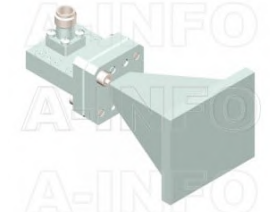

LB-180550-1.85FSPO Broadband Horn Antenna 18-55GHz 15dB Gain 1.85mm Female



LB-60670-1.85F Broadband Horn Antenna 6-67GHz 13dB Gain 1.85mm Female



LB-60670-1.85FSPO Broadband Horn Antenna 6-67GHz 13dB Gain 1.85mm Female



LB-1001100-1.0F Broadband Horn Antenna 10-110GHz 13dB Gain 1.0mm Female



LB-1401100-1.0F Broadband Horn Antenna 14-110GHz 13dB Gain 1.0mm Female



LB-SJ-40400-KF Broadband Dual Polarization Horn Antenna 4-40GHz 12dB Gain 2.92mm Female



LB-SJ-40400-KFSPO Broadband Dual Polarization Horn Antenna 4-40GHz 12dB Gain 2.92mm Female



LB-SJ-40400-2.4F Broadband Dual Polarization Horn Antenna 4-40GHz 12dB Gain 2.4mm Female



LB-SJ-40400-2.4FSPO Broadband Dual Polarization Horn Antenna 4-40GHz 12dB Gain 2.4mm Female



LB-SJ-50500-2.4F Broadband
Dual Polarization Horn Antenna
5-50GHz 12dB Gain 2.4mm
Female



LB-SJ-50500-1.85F Broadband
Dual Polarization Horn Antenna
5-50GHz 12dB Gain 1.85mm
Female

About this Datasheet

<ul style="list-style-type: none"> • Product Information Product Link: https://www.ainfoinc.com/lb-1801100-1-0f-broadband-horn-antenna-18-110-ghz-14db-gain-1-0mm-female Data subject to change without notice. © A-INFO INC. 2024. All Rights Reserved 	<ul style="list-style-type: none"> • Contact Us Address: 60 Tesla, Irvine, CA 92618, USA Website: www.ainfoinc.com Email: sales@ainfoinc.com 	<ul style="list-style-type: none"> • Phone & Fax Phone: +1-949-639-9688 +1-949-639-9608 Fax: +1-949-639-9670
---	--	---